

Nickel-Plated Brass DOT Fittings NPTF/INCH

Connections 1/8", 1/4", 3/8", 1/2" NPTF

- Meets all requirements for Federal DOT Standard 571.106* 49 CFR Ch. V
- Temperature Range: -40°F to 200°F working pressure 0 - 1000 psi
- Electroless Nickel Plated brass body with a low temperature BUNA-N O-ring
- For use with DOT approved Nylon® tubing
- Compressed air applications
- Available in standard thread, Coated LOCTITE (Vibra-Seal 516) THREAD or **Pro-Fit®** style thread
- Consult factory for availability



* Our fittings are designed for use on all pneumatic circuits and assemblies other than brake assemblies between the frame and axle, or between a towed and towing vehicle.

TECHNICAL SPECIFICATIONS

Material	Electroless Nickel-plated brass OT58 UNI 5705
*Collet	Brass OT58 UNI 5705, nickel plated
*O-ring	Buna-N [Viton® available], Epdm available
Threads	1/8", 1/4", 3/8", 1/2" NPTF
Operating pressure	0 - 1000 psi
Fluid	Compressed air [for other types of fluid please contact our engineers]
Tube diameter	5/32", 1/4", 3/8", 1/2"

Fittings Mod. D6510

Male connector

DIMENSIONS

Mod.	OD A	THREAD D	C	F	G	H	I	L	SW	SW1
D6510 53-02	5/32	1/8	.196	.346	.551	.315	-	.807	.472	.098
D6510 53-04	5/32	1/4	.354	.346	.629	.472	-	.964	.551	.098
D6510 04-02	1/4	1/8	.287	.460	.551	.315	.165	.984	.472	.157
D6510 04-04	1/4	1/4	.405	.460	.629	.472	.165	1.102	.551	.157
D6510 04-06	1/4	3/8	.425	.460	.866	.472	.165	1.122	.748	.157
D6510 06-02	3/8	1/8	.393	.606	.776	.315	.244	1.240	.669	.157
D6510 06-04	3/8	1/4	.551	.606	.776	.472	.244	1.398	.669	.275
D6510 06-06	3/8	3/8	.354	.606	.866	.472	.244	1.201	.748	.275
D6510 06-08	3/8	1/2	.374	.606	1.004	.610	.244	1.221	.866	.275
D6510 08-04	1/2	1/4	.563	.720	.866	.472	.362	1.427	.748	.275
D6510 08-06	1/2	3/8	.484	.720	.866	.472	.362	1.378	.748	.393
D6510 08-08	1/2	1/2	.425	.720	1.004	.610	.362	1.319	.866	.393

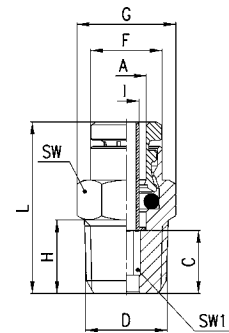

Fittings Mod. D6463

Female connector

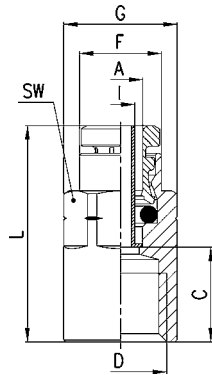

DIMENSIONS

Part No.	OD A	THREAD D	C	F	G	I	L	SW
D6463 53-02	5/32	1/8	.393	.354	.512	-	1.004	.472
D6463 53-04	5/32	1/4	.551	.354	.649	-	1.161	.590
D6463 04-02	1/4	1/8	.386	.460	.512	.165	1.102	.472
D6463 04-04	1/4	1/4	.543	.468	.649	.165	1.240	.590
D6463 06-04	3/8	1/4	.512	.606	.728	.244	1.358	.669
D6463 06-06	3/8	3/8	.551	.606	.787	.244	1.397	.669

Fittings Mod. D6700

Cartridge

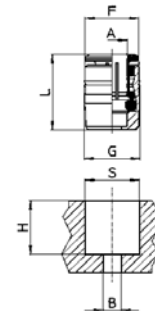

Mod.	OD A	F	G	I	L	S	H	B
D6700 53-00	5/32	.338	.354	-	.629	.344	.433	.137
D6700 04-00	1/4	.464	.480	.165	.708	.470	.472	.157
D6700 06-00	3/8	.622	.637	.244	.846	.627	.649	.315
D6700 08-00	1/2	.740	.755	.362	.885	.746	.668	.413

- * Hole tolerances: +0.002-0.000 [in.]
- * For plastic (non-metal) manifolds, reduce all hole dimensions "S" by 0.02 mm [0.001 in.]
- * INSTALLATION: Drill or bore hole per specifications per size of cartridge (dimensions H and S).
- * Smooth or ream hole dimensions to hole tolerances.
- * Simply press fit cartridge into hole with an evenly distributed force over the top surface.
- * Removal of the collet ring is not necessary.
- * Cartridge fittings are useful for installations in various manifolds and/or distribution blocks when drilling and tapping are not desirable.

Fittings Mod. D6580

Union

DIMENSIONS

Part No.	OD A	F	G	I	L	N
D6580 53-00	5/32	.330	.354	-	1.259	.610
D6580 04-00	1/4	.460	.472	.165	1.437	.696
D6580 06-00	3/8	.606	.669	.244	1.732	.846
D6580 08-00	1/2	.720	.748	.362	1.830	.893

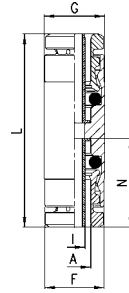

Fittings Mod. D6590

Bulkhead Union

DIMENSIONS

Part No.	OD A	B	F	I	L	N	MAX	SW	SW1	T
D6590 53-00	5/32	M10X1	.338	-	1.260	.610	.413	.551	.551	.925
D6590 04-00	1/4	M14X1	.492	.165	1.437	.696	.452	.669	.669	.984
D6590 06-00	3/8	M18X1	.622	.244	1.732	.846	.511	.866	.866	1.082
D6590 08-00	1/2	M20X1	.740	.362	1.830	.893	.570	.944	.944	1.141

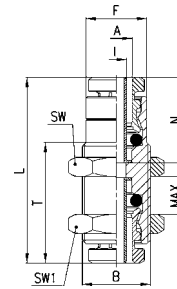

Fittings Mod. D6520

Swivel Elbow

DIMENSIONS

Mod.	OD A	THREAD D	C	E	F	H	I	M	SW	SW1
		NPTF								
D6520 53-02	5/32	1/8	.138	.649	.354	.315	-	.748	.315	.472
D6520 53-04	5/32	1/4	.138	.689	.354	.472	-	.748	.315	.551
D6520 04-02	1/4	1/8	.157	.669	.500	.315	.165	.846	.354	.472
D6520 04-04	1/4	1/4	.157	.708	.500	.472	.165	.846	.354	.551
D6520 04-06	1/4	3/8	.157	.689	.500	.472	.165	.846	.354	.748
D6520 06-02	3/8	1/8	.256	.807	.649	.315	.244	1.102	.512	.551
D6520 06-04	3/8	1/4	.256	.846	.649	.472	.244	1.102	.512	.551
D6520 06-06	3/8	3/8	.256	.827	.649	.472	.244	1.102	.512	.748
D6520 06-08	3/8	1/2	.256	.905	.649	.610	.244	1.102	.512	.866
D6520 08-04	1/2	1/4	.315	.905	.767	.472	.362	1.181	.590	.669
D6520 08-06	1/2	3/8	.315	.866	.767	.472	.362	1.181	.590	.748
D6520 08-08	1/2	1/2	.315	.945	.767	.610	.362	1.181	.590	.866

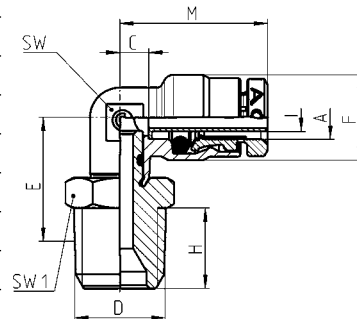

Fittings Mod.D6500

Male Elbow



DIMENSIONS

Mod.	OD		THREAD		C	E	F	H	I	M	SW
	A	D	D	D							
D6500 04-02	1/4	1/8	.157	.571	.500	.472	.165	.846	.354		
D6500 04-04	1/4	1/4	.157	.472	.500	.472	.165	.846	.354		
D6500 06-04	3/8	1/4	.256	.551	.649	.472	.244	1.102	.512		
D6500 06-06	3/8	3/8	.256	.512	.649	.472	.244	1.102	.512		

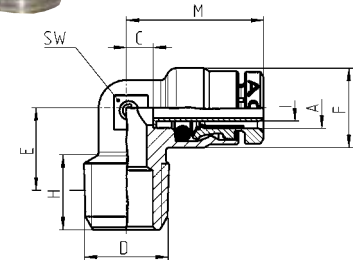

Fittings Mod. D6550

Union Elbow



DIMENSIONS

Part No.	OD		C	F	I	M	SW
	A	D					
D6550 53-00	5/32	.138	.354	-	.748	.315	
D6550 04-00	1/4	.157	.500	1.65	.846	.354	
D6550 06-00	3/8	.256	.649	.244	1.102	.512	
D6550 08-00	1/2	.315	.767	.362	1.181	.590	

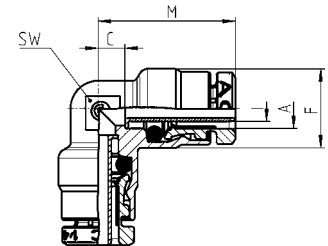

Fittings Mod. D6430

Branch Tee Swivel

DIMENSIONS

Mod.	OD		NPTF	C	E	F	H	I	L	SW	SW1
	A	D									
D6430 53-02	5/32	1/8	.138	.649	.354	.315	-	1.496	.315	.472	
D6430 53-04	5/32	1/4	.138	.689	.354	.472	-	1.496	.315	.551	
D6430 04-02	1/4	1/8	.157	.669	.500	.315	.165	1.692	.354	.472	
D6430 04-04	1/4	1/4	.157	.708	.500	.472	.165	1.692	.354	.551	
D6430 04-06	1/4	3/8	.157	.689	.500	.472	.165	1.692	.354	.748	
D6430 06-04	3/8	1/4	.256	.846	.649	.472	.244	2.204	.512	.551	
D6430 06-06	3/8	3/8	.256	.827	.649	.472	.244	2.204	.512	.748	
D6430 06-08	3/8	1/2	.256	.905	.649	.610	.244	2.204	.512	.866	
D6430 08-04	1/2	1/4	.315	.905	.767	.472	.362	2.362	.590	.669	
D6430 08-06	1/2	3/8	.315	.866	.767	.472	.362	2.362	.590	.748	
D6430 08-08	1/2	1/2	.315	.945	.767	.610	.362	2.362	.590	.866	

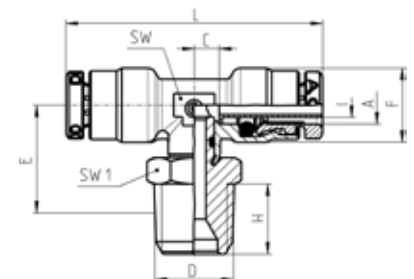

Fittings Mod. D6440

Run Tee Swivel

DIMENSIONS

Mod.	OD A	NPTF D	C	E	F	H	I	L	M	SW	SW1
D6440 53-02	5/32	1/8	.138	.649	.354	.315	-	1.594	.748	.315	.472
D6440 53-04	5/32	1/4	.138	.689	.354	.472	-	1.693	.748	.315	.551
D6440 04-02	1/4	1/8	.157	.669	.500	.315	.165	1.712	.846	.354	.472
D6440 04-04	1/4	1/4	.157	.708	.500	.472	.165	1.810	.846	.354	.551
D6440 04-06	1/4	3/8	.157	.689	.500	.472	.165	1.830	.846	.354	.748
D6440 06-04	3/8	1/4	.256	.846	.649	.472	.244	2.204	1.102	.512	.551
D6440 06-06	3/8	3/8	.256	.827	.649	.472	.244	2.244	1.102	.512	.748
D6440 06-08	3/8	1/2	.256	.905	.649	.610	.244	2.341	1.102	.512	.866
D6440 08-04	1/2	1/4	.315	.905	.767	.472	.362	2.342	1.181	.590	.669
D6440 08-06	1/2	3/8	.315	.866	.767	.472	.362	2.342	1.181	.590	.748
D6440 08-08	1/2	1/2	.315	.945	.767	.610	.362	2.460	1.181	.590	.866

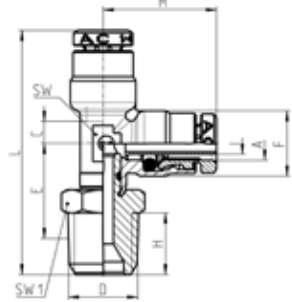

Fittings Mod. D6540

Union Tee

DIMENSIONS

Mod.	OD A	C	F	I	L	M	SW
D6540 53-00	5/32	.138	.354	-	1.496	.748	.315
D6540 04-00	1/4	.157	.500	.165	1.692	.846	.354
D6540 06-00	3/8	.256	.649	.244	2.204	1.102	.512
D6540 08-00	1/2	.315	.767	.362	2.362	1.181	.590

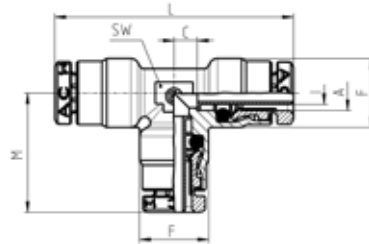

Fittings Mod. D6560

Union "Y"

DIMENSIONS

Part No.	OD A	C	F	I	L	M
D6560 53-00	5/32	.236	.826	-	1.456	.393
D6560 04-00	1/4	.236	.964	.165	1.614	.492

